

Digital Lever Cylinder AX (Z5)

Z550.905001
16.09.2024

DE Kurzanleitung
FR Guide abrégé
NL Korte handleiding
IT Guida breve
DK Korte vejledning
SE Snabbguide

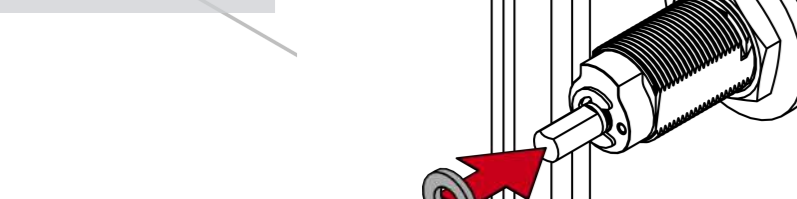

4. Structure of Lever Cylinder AX

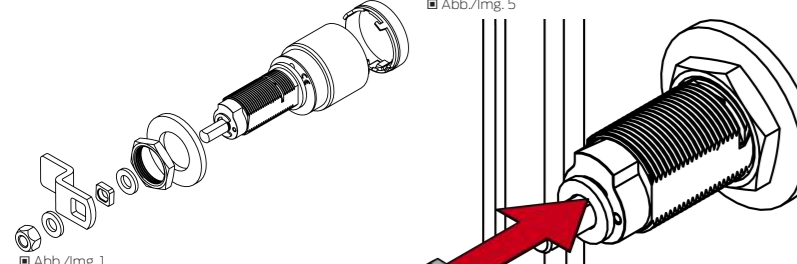

5. Installing the lever cylinder

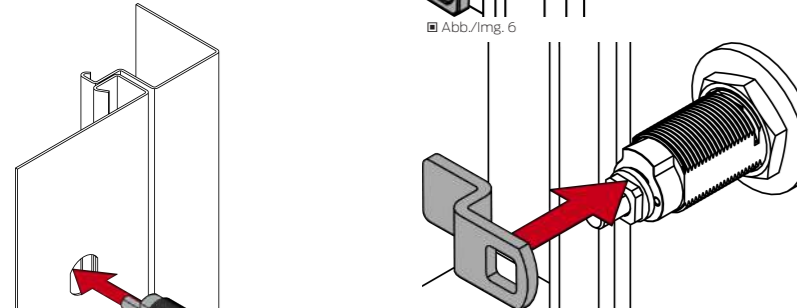

4. Structure of Lever Cylinder AX

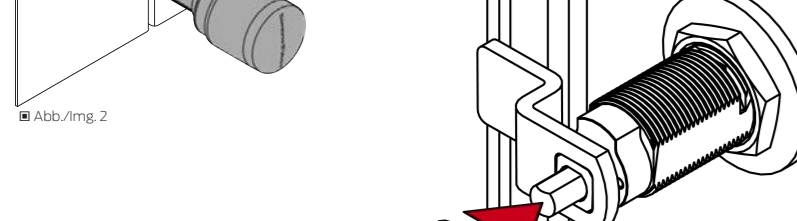

5. Installing the lever cylinder

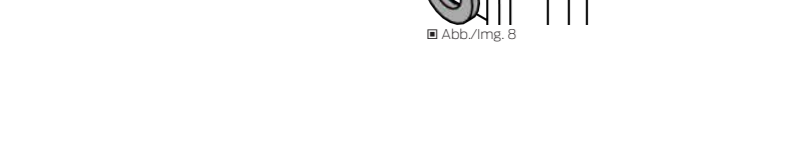

4. Structure of Lever Cylinder AX

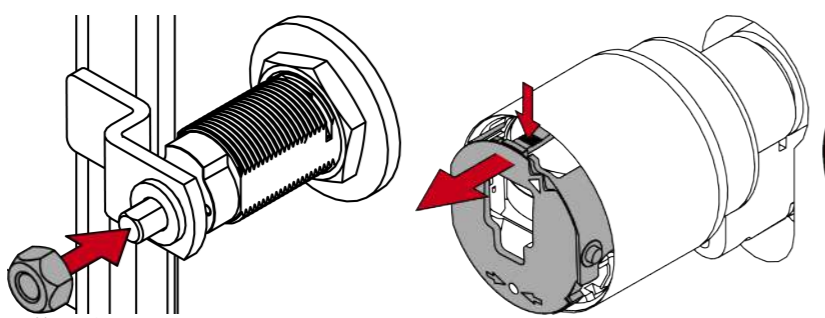

7. Battery replacement

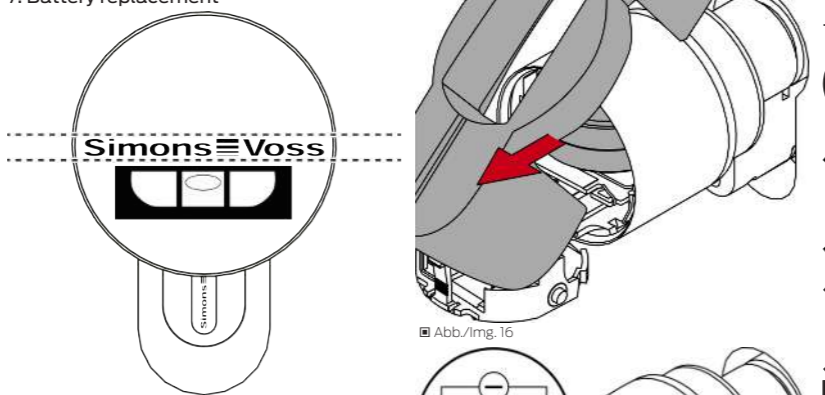

7. Battery replacement

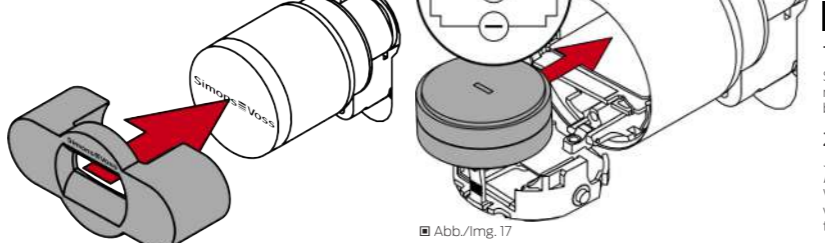

7. Battery replacement

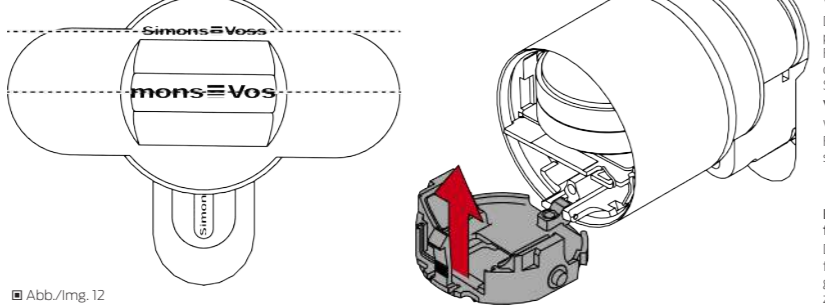

7. Battery replacement

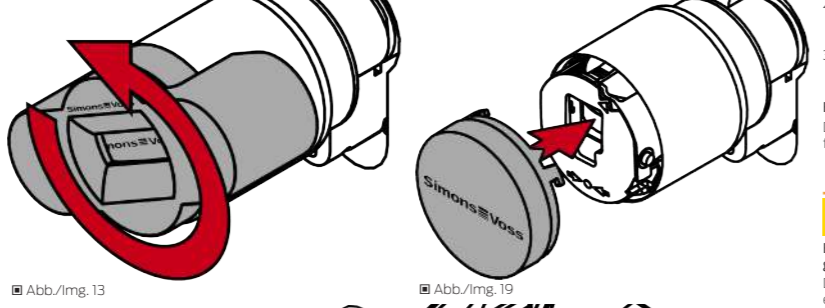

7. Battery replacement

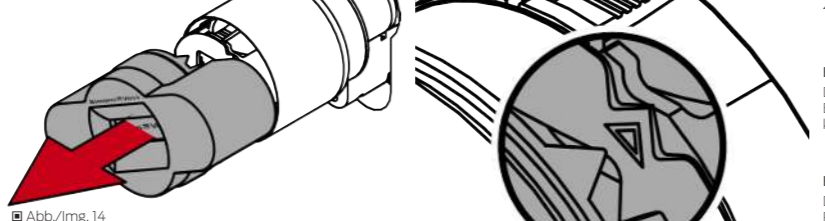

7. Battery replacement



7. Battery replacement



7. Battery replacement

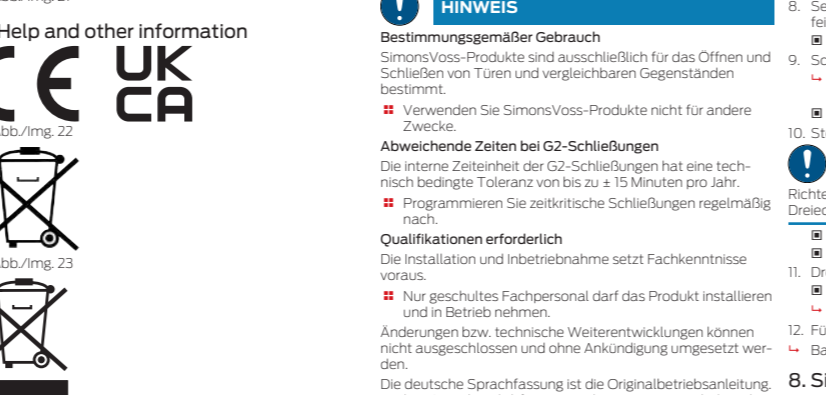

7. Battery replacement

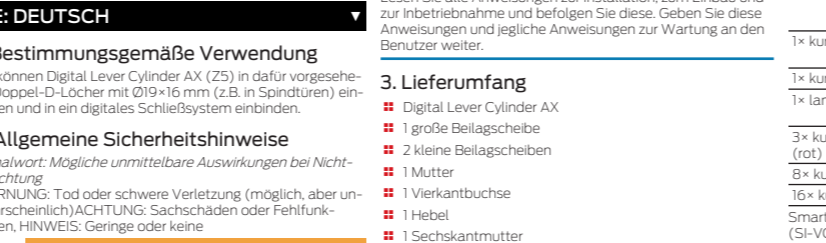

7. Battery replacement

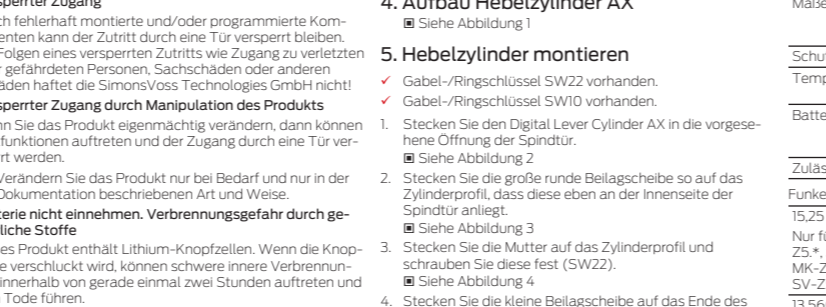

7. Battery replacement

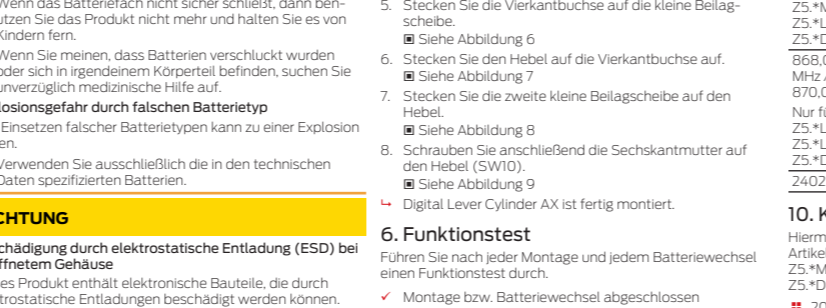

7. Battery replacement

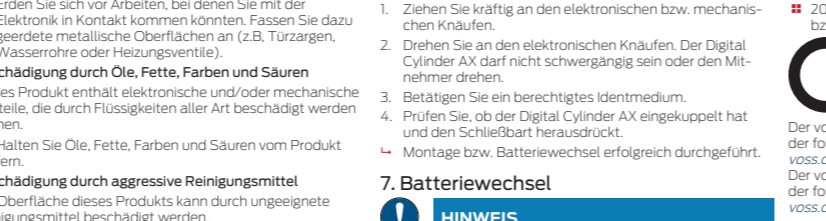

7. Battery replacement

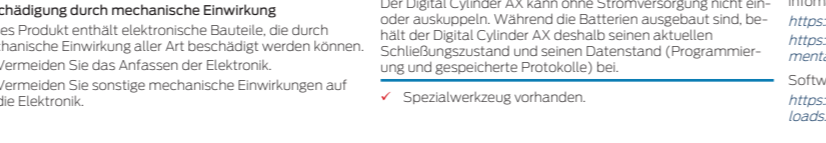

7. Battery replacement

7. Battery replacement

1. Remove the battery cover (see image 1).
2. Turn the battery cover clockwise (see image 2).
3. Remove the battery cover (see image 3).
4. Remove the battery cover (see image 4).
5. Remove the battery cover (see image 5).
6. Remove the battery cover (see image 6).
7. Remove the battery cover (see image 7).
8. Remove the battery cover (see image 8).
9. Remove the battery cover (see image 9).
10. Remove the battery cover (see image 10).
11. Remove the battery cover (see image 11).
12. Remove the battery cover (see image 12).
13. Remove the battery cover (see image 13).
14. Remove the battery cover (see image 14).
15. Remove the battery cover (see image 15).
16. Remove the battery cover (see image 16).
17. Remove the battery cover (see image 17).
18. Remove the battery cover (see image 18).
19. Remove the battery cover (see image 19).
20. Remove the battery cover (see image 20).

8. Indication

Indication	Signification
1* court (rouge)	Support d'identification accepté, actionnement normal
1* court (vert)	Support d'identification non autorisé
1* long, 1* court (vert)	Mode FlipPop / engage
1* long, 1* court (vert)	Mode FlipPop / désengage
3* court après remplissage des piles (rouge)	Remplacement des piles effectué
8* court avant engagement (rouge)	Niveau d'avertissement des piles 1
16* court avant engagement (rouge)	Niveau d'avertissement des piles 2

9. Caractéristiques techniques

Bouton de dimensions (ØxL) Ø 32 mm x 39,5 mm (électro- mécanique), Ø 32 mm x 37,5 mm (mécanique)

Classe de protection IP54 (standard), IP67 (WP)

Plage de température (fonctionnement) -25°C à +65°C (selon DIN EN 15684)

Type des piles 2 piles CR2450 3 V (lithium) par bouton de lecture, pour piles boutons; 6x

Émissions de radio 15,25 kHz - 72,03 kHz 10 dBµA/m (distance 3 m)

Seulement pour les numéros d'article: -SV-25*, -SV-25*+LN*, -MK-25*, -MK-25*+LN*, -MK-25*+DM*, -SV-25*+DM*, -SV-25*+DM*+LN*, -MK-25*+DM*+LN*, -MK-25*+DM*+LN*+OSS*)

ERP <25 mW

2402 MHz - 2480 MHz 2,5 mW

10. Déclaration de conformité

La société SimonsVoss Technologies GmbH déclare par la présente que les articles (-SV-25*+LN*, -SV-25*+LN*+OSS*) sont conformes aux directives suivantes:

- 2014/53/EU - RED- ou pour UK: UK statutory 2017 No. 1206 -Radio equipment
- 2011/65/EU -RoHS- ou pour UK: UK statutory 2012 No. 3032 -RoHS-mentarions

Le texte intégral de la déclaration de conformité CE est disponible à l'adresse Internet suivante: www.simons-voss.com/fr/certificates.html

Le texte intégral de la déclaration de conformité UK est disponible à l'adresse Internet suivante: www.simons-voss.com/fr/certificates.html

11. Aide et autres informations

Documentation/documents

<https://www.simons-voss.com/fr/documents.html>

Logiciels et pilotes

<https://www.simons-voss.com/fr/telechargements/telechargements-de-logiciels.html>

Déclarations de conformité

<https://www.simons-voss.com/fr/certificates.html>

Déclaration de conformité relative à la directive 2014/53/EU

Par la présente, SimonsVoss Technologies GmbH certifie que l'appareil de transmission radio (-SV-25*+LN*, -SV-25*+LN*+OSS*) est conforme aux exigences de la Directive 2014/53/EU.

Vous pouvez consulter la déclaration de conformité dans sa totalité sur la page d'accueil: <http://www.simons-voss.com/fr/certificates.html>

Vous ne jetez pas l'appareil (-SV-25*+LN*, -SV-25*+LN*+OSS*) avec vos ordures

avec vos ordures ménagères.

11. Hilfe und andere Informationen

Informations/Documents

<https://www.simons-voss.com/de/documents.html>

Logiciels et pilotes

<https://www.simons-voss.com/de/home/infolcenter/documentation>

Déclarations de conformité

<https://www.simons-voss.com/de/en/certificates.html>

Déclaration de conformité relative à la directive 2014/53/EU

Par la présente, SimonsVoss Technologies GmbH déclare que l'appareil de transmission radio (-SV-25*+LN*, -SV-25*+LN*+OSS*) est conforme aux exigences de la Directive 2014/53/EU.

Vous pouvez consulter la déclaration de conformité dans sa totalité sur la page d'accueil: <http://www.simons-voss.com/de/certificates.html>

Vous ne jetez pas l'appareil (-SV-25*+LN*, -SV-25*+LN*+OSS*) avec vos ordures

ménagères.

11. Hilfe und andere Informationen

Informations/Documents

<https://www.simons-voss.com/de/documents.html>

Logiciels et pilotes

<https://www.simons-voss.com/de/home/infolcenter/documentation>

Déclarations de conformité

<https://www.simons-voss.com/de/en/certificates.html>

Déclaration de conformité relative à la directive 2014/53/EU

Par la présente, SimonsVoss Technologies GmbH déclare que l'appareil de transmission radio (-SV-25*+LN*, -SV-25*+LN*+OSS*) est conforme aux exigences de la Directive 2014/53/EU.

Vous pouvez consulter la déclaration de conformité dans sa totalité sur la page d'accueil: <http://www.simons-voss.com/de/certificates.html>

Vous ne jetez pas l'appareil (-SV-25*+LN*, -SV-25*+LN*+OSS*) avec vos ordures

ménagères.

11. Hilfe und andere Informationen

Informations/Documents

<https://www.simons-voss.com/de/documents.html>

Logiciels et pilotes

<https://www.simons-voss.com/de/home/infolcenter/documentation>

Déclarations de conformité

<https://www.simons-voss.com/de/en/certificates.html>

Déclaration de conformité relative à la directive 2014/53/EU

Par la présente, SimonsVoss Technologies GmbH déclare que l'appareil de transmission radio (-SV-25*+LN*, -SV-25*+LN*+OSS*) est conforme aux exigences de la Directive 2014/53/EU.

Vous pouvez consulter la déclaration de conformité dans sa totalité sur la page d'accueil: <http://www.simons-voss.com/de/certificates.html>

Vous ne jetez pas l'appareil (-SV-25*+LN*, -SV-25*+LN*+OSS*) avec vos ordures

ménagères.

11. Hilfe und andere Informationen

Informations/Documents

<https://www.simons-voss.com/de/documents.html>

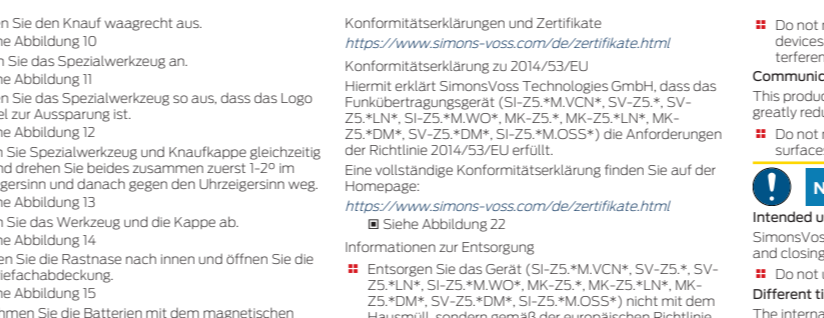

7. Battery replacement

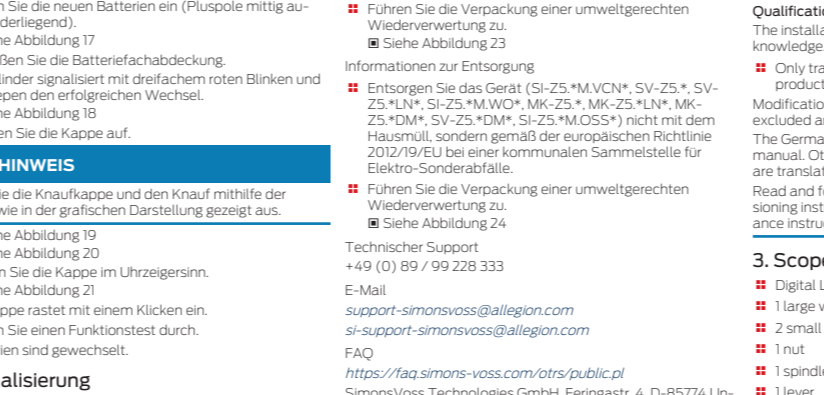

7. Battery replacement

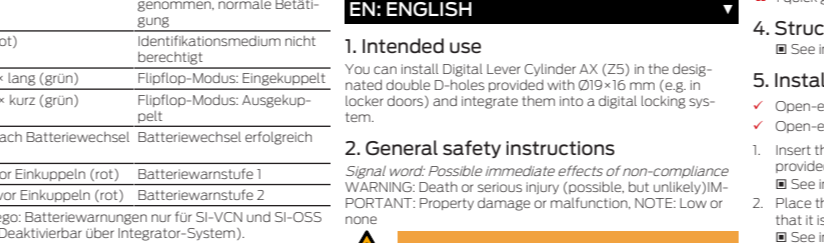

7. Battery replacement

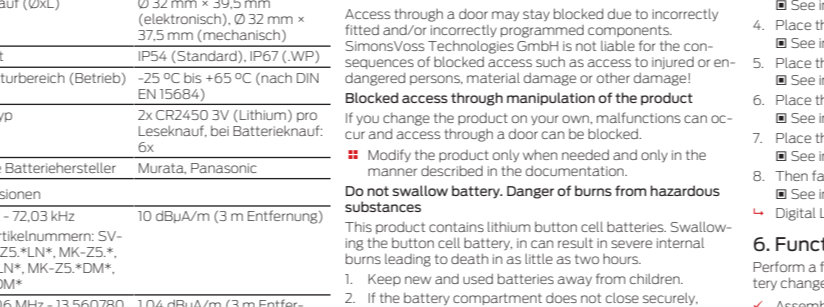

7. Battery replacement

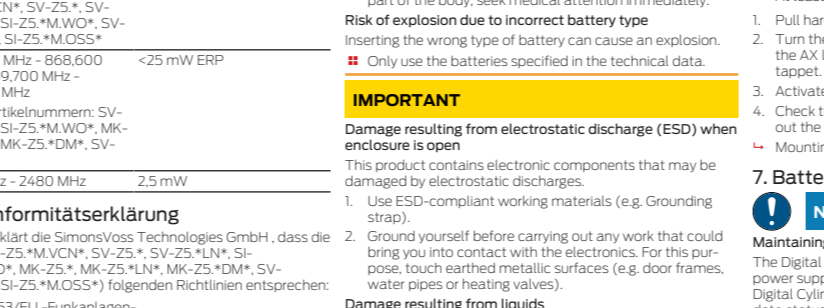

7. Battery replacement

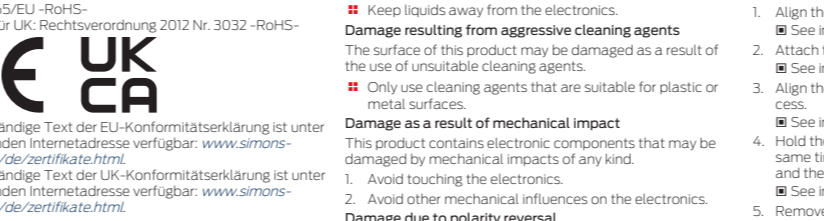

7. Battery replacement

11. Hilfe und andere Informationen

Informations/Documents

<https://www.simons-voss.com/de/documents.html>

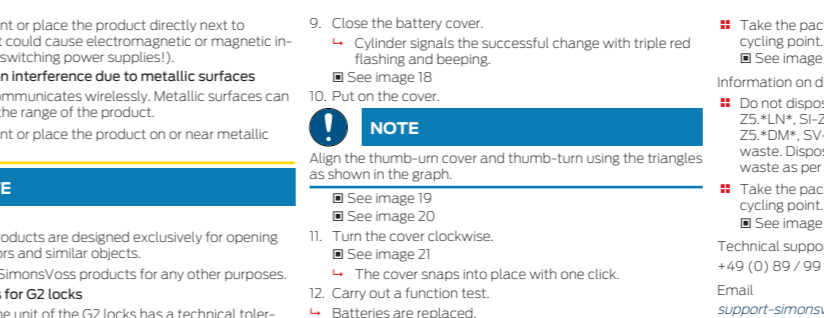

7. Battery replacement

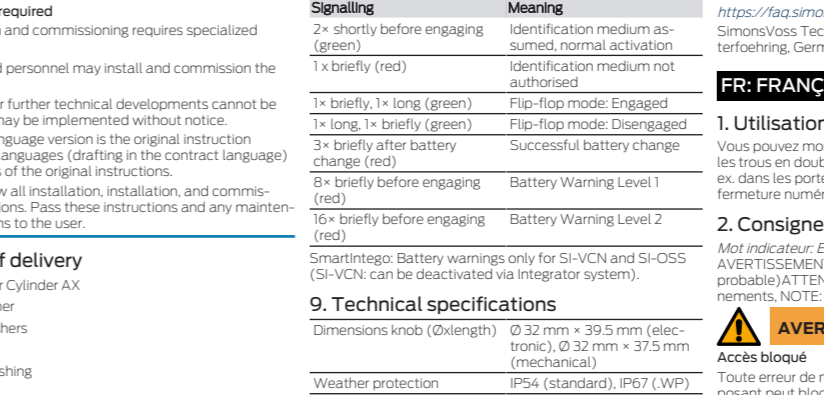

7. Battery replacement

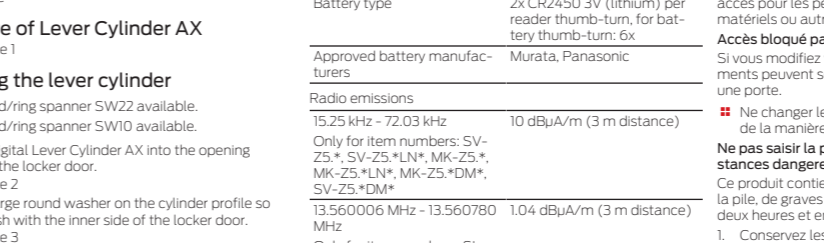

7. Battery replacement

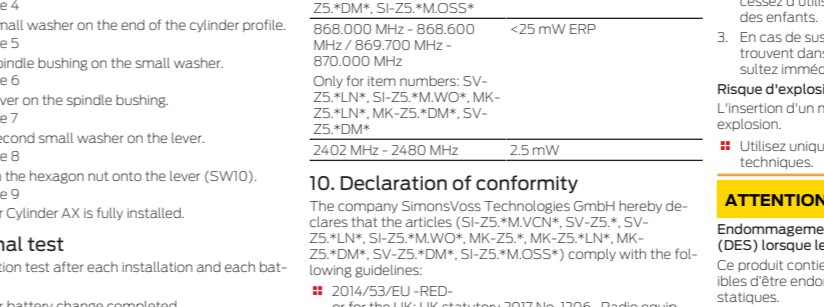

7. Battery replacement



7. Battery replacement

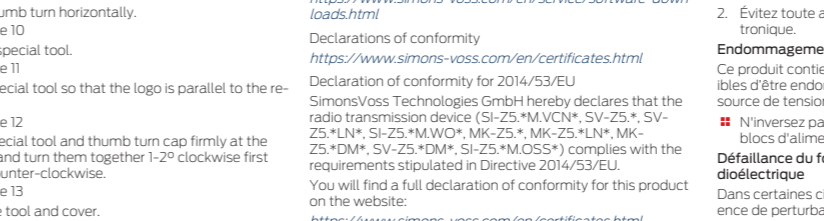

7. Battery replacement

11. Hilfe und andere Informationen

Informations/Documents

<https://www.simons-voss.com/de/documents.html>

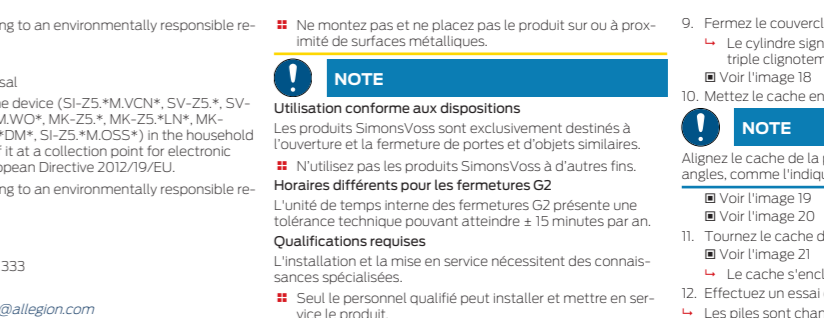

7. Battery replacement

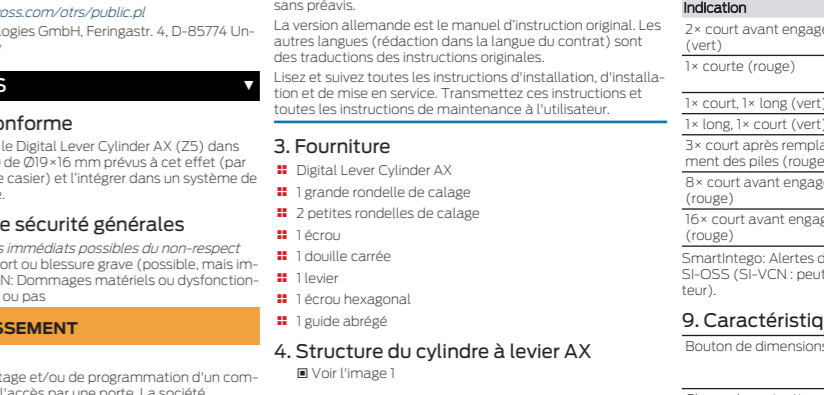

7. Battery replacement

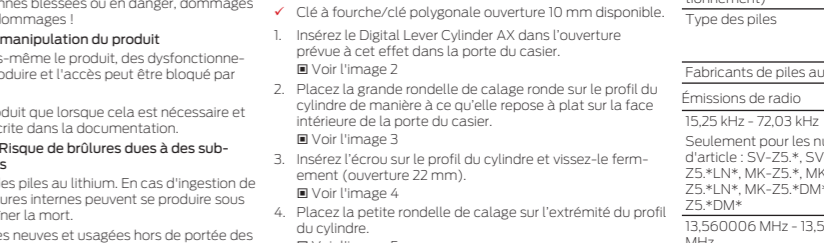

7. Battery replacement

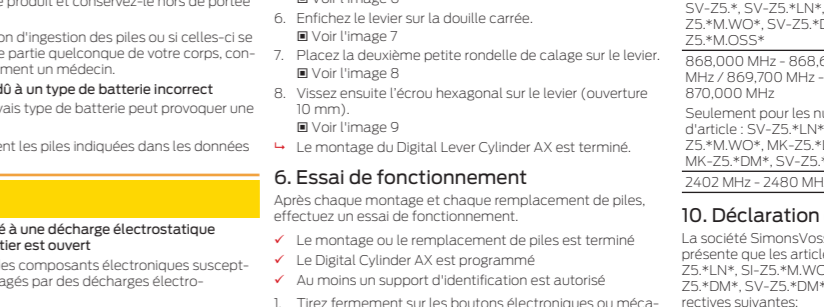

7. Battery replacement

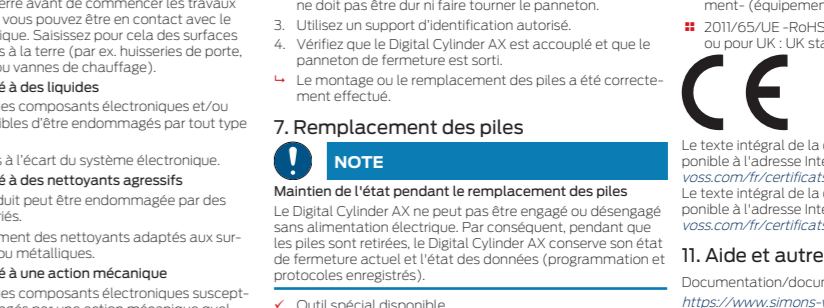

7. Battery replacement

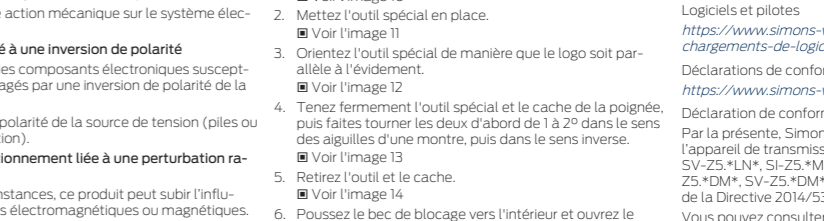

7. Battery replacement

11. Hilfe und andere Informationen

Informations/Documents

<https://www.simons-voss.com/de/documents.html>

1. Bestimmungsgemäße Verwendung

Sie können Digital Lever Cylinder AX (Z5) in dafür vorgesehene Doppel-Locher mit Ø19x16 mm (z.B. in Spindlern) einbauen und in ein digitales Schließsystem einbinden.

2. Allgemeine Sicherheits Hinweise

Signalwort: Mögliche unmittelbare Auswirkungen bei Nichtbeachtung: Tode oder schwere Verletzung (möglich, aber unwahrscheinlich) ACHTUNG: Sachschäden oder Fehlfunktionen. HINWEIS: Geringe oder keine

3. Lieferumfang

- 1 Digital Lever Cylinder AX
- 1 große Beilagscheibe
- 2 kleine Beilagscheiben
- 1 Mutter
- 1 Vierkantbushse
- 1 Hebel
- 1 Sechskantmutter
- 1 Kurzanleitung

4. Aufbau und Hebelzylinder AX

Durch fehlerhaft montierte und/oder programmierte Komponenten kann der Zutritt durch eine Tür versperrt bleiben. Für Folgen eines versperrten Zutritts wie Zugang zu verletzten oder gefährdeten Personen, Sachschäden oder anderen Schäden haftet die SimonsVoss Technologies GmbH nicht!

5. Hebelzylinder montieren

- Gabel-/Ringschlüssel SW22 vorhanden.
- Gabel-/Ringschlüssel SW10 vorhanden.

6. Funktionstest

- Montage bzw. Batteriewechsel abgeschlossen
- Digital Cylinder AX programmiert
- Mindestens ein Identmedium berechtigt

7. Batteriewechsel

Spezialwerkzeug vorhanden.

1. Intended use

You can install Digital Lever Cylinder AX (Z5) in the designated double D-holes provided with Ø19x16 mm (e.g. in lockers doors) and integrate them into a digital locking system.

2. General safety instructions

Signal word: Possible immediate effects of non-compliance: WARNING: Death or serious injury (possible, but unlikely) IMPORTANT: Property damage or malfunction. NOTE: Low or no

3. Scope of delivery

- 1 Digital Lever Cylinder AX
- 1 large washer
- 2 small washers
- 1 nut
- 1 spindle bushing
- 1 lever
- 1 hex nut
- 1 quick guide

4. Installing the lever cylinder

- Open-ended/ring spanner SW22 available.
- Open-ended/ring spanner SW10 available.

5. Installing the lever cylinder

- Insert the Digital Lever Cylinder AX into the opening provided in the locker door.
- See image 2

- Place the large round washer on the cylinder profile so that it is flush with the inner side of the locker door.
- See image 3

- Place the nut on the cylinder profile and fasten it into the hole (SW22).
- See image 4

- Place the small washer on the end of the cylinder profile.
- See image 5

- Place the spindle bushing on the small washer.
- See image 6

- Place the lever on the spindle bushing.
- See image 7

- Place the second small washer on the lever.
- See image 8

- Then fasten the hexagon nut onto the lever (SW10).
- See image 9

6. Functional test

- Perform a function test after each installation and each battery change.
- Assembly or battery change completed
- Digital Cylinder AX programmed
- At least one identification medium authorised

- Pull hard on the electronic or mechanical thumb-turns.
- Turn the electronic thumb-turns. The Digital Cylinder AX the AX locking cylinder must not be tight, nor rotate the tapet.

- Activate an authorised identification medium.
- Check that the Digital Cylinder AX engages and pushes out the locking bit.
- Mounting or battery change successfully completed.

7. Battery replacement

NOTE

Maintaining the condition during battery replacement

The Digital Cylinder AX cannot engage or disengage without power supply. Therefore, while the batteries are removed, the Digital Cylinder AX retains its current locking status and its data status (programming and stored logs).

- Special tool available.
- Align the thumb turn horizontally.
- See image 10

- Attach the special tool.
- See image 11

- Align the special tool so that the logo is parallel to the recesses.
- See image 12

- Hold the special tool and thumb turn cap firmly at the same time and turn them together 1/2° clockwise first and then counter-clockwise.
- See image 13

- Remove the batteries with the special magnetic tool.
- See image 16

- Insert the new batteries (positive poles touching in the middle).
- See image 17

1. Intended use

You can install Digital Lever Cylinder AX (Z5) in the designated double D-holes provided with Ø19x16 mm (e.g. in locker doors) and integrate them into a digital locking system.

2. General safety instructions

Signal word: Possible immediate effects of non-compliance: WARNING: Death or serious injury (possible, but unlikely) IMPORTANT: Property damage or malfunction. NOTE: Low or no

3. Scope of delivery

- 1 Digital Lever Cylinder AX
- 1 large washer
- 2 small washers
- 1 nut
- 1 spindle bushing
- 1 lever
- 1 hex nut
- 1 quick guide

4. Installing the lever cylinder

- Open-ended/ring spanner SW22 available.
- Open-ended/ring spanner SW10 available.

5. Installing the lever cylinder

- Insert the Digital Lever Cylinder AX into the opening provided in the locker door.
- See image 2

- Place the large round washer on the cylinder profile so that it is flush with the inner side of the locker door.
- See image 3

- Place the nut on the cylinder profile and fasten it into the hole (SW22).
- See image 4

- Place the small washer on the end of the cylinder profile.
- See image 5

- Place the spindle bushing on the small washer.
- See image 6

- Place the lever on the spindle bushing.
- See image 7

- Place the second small washer on the lever.
- See image 8

- Then fasten the hexagon nut onto the lever (SW10).
- See image 9

6. Functional test

- Perform a function test after each installation and each battery change.
- Assembly or battery change completed
- Digital Cylinder AX programmed
- At least one identification medium authorised

- Pull hard on the electronic or mechanical thumb-turns.
- Turn the electronic thumb-turns. The Digital Cylinder

